



Made in the
United States of America

FreeStyle 8400 - Installation Guide

When Receiving and Installing FreeStyle

Please inspect your product carefully. If any of the tiles appear damaged when you open the box do not attempt to install it. **If you encounter any condition or defects during installation which could jeopardize the installation or affect the installation procedure you should STOP immediately and Contact Statguard Flooring Customer Service Desk: (781) 821-8370.**

FreeStyle Basics

FreeStyle is an 18.5" x 18.5" interlocking floor tile. It is a free-lay tile system and does not require use of adhesives. FreeStyle's "built-in" subfloor permits installation over uneven surfaces with minimal preparation of the floor. FreeStyle may be installed directly over concrete, wood, tile or other standard floors as well as access floors. It is not recommended for installation over carpets or any floor that is designed to compress or move.

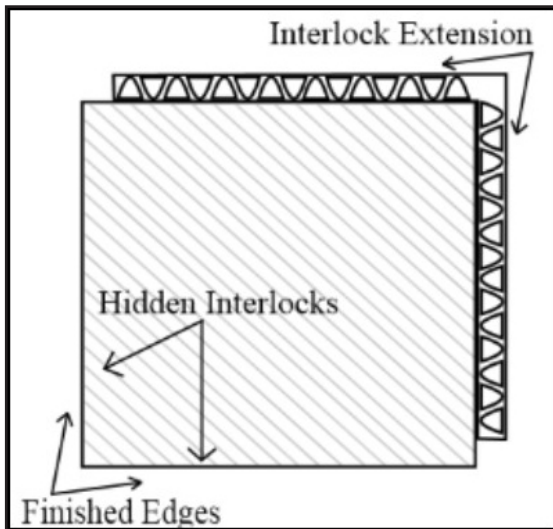

Figure 1 Free Style Tiles

The interlock system uses two "Interlock Extensions" that are visible from the top of the tile, and two (2) "Hidden Interlocks" under the Finished Edges that are visible from the bottom of the tile. (See Figure 1) To install, you will mate the Hidden Interlocks on one tile with the Interlock Extensions on adjacent tiles.

Tile Flatness

FreeStyle utilizes a patented "zipper" interlock system, designed for adhesive free installation and providing tight seams, with a flexible, moisture proof base that is manufactured with recycled content. This design results in a slight dipping at the edges of the tile which is normal. Some amount of "cupping" may also be present when removed from the box and on initial installation. This will diminish over time as the floor "settles in" following installation.

Receiving and Storing FreeStyle

Store tiles flat and properly conditioned prior to installation. Never store the tiles upright. Stack the boxes of tiles (or loose tiles) on a flat surface with the edges of the boxes flush to one another. Unconditioned tiles, improper storage or overhanging edges will distort the shape and size of the tiles and cause difficulty when installing. Tiles may vary up to 1/16" when conditioned. These variations will not negatively affect installation if conditioned tiles are installed in accordance with these instructions. Size variation can be much greater if the air temperature and slab temperature are not as specified.

Tools

- Dead-blow hammer (21 to 42 oz) available at hardware stores (Required)
- **NOTE: Rubber mallets do not work**
- Utility knife and straight edge. (Required)
- Carpenter's square. (Required)
- Chalk line (Required)
- Tape Measure (Required)
- Two-sided carpet tape - Johnsonite Power Tape or equal (Required on jobs over 500 sq. ft.)
- Table saw or circular saw (for making multiple straight cuts). (Required)
- *(Safety devices must be in place and Manufacturer's instructions and safety precautions must be observed at all times while using power equipment)*
- Sharpie or similar marker to mark tile for cutting
- 1/4" Spacers
- Jig saw, orbital or similar cutting tool for irregular cuts. Use a medium tooth finishing blade (Recommended)
- A 20" or larger, tile cutter (optional). These are cost effective on large jobs. Recommended brand is Bullet RCT 20 Magnum Shears.

WARNING: Appropriate caution and procedures must be used if removing a preexisting resilient floor covering. Many older vinyl sheets, floor tile or asphaltic floor coverings contain asbestos that is not readily identifiable. Removal of these materials must comply with various federal, state and local regulations pertaining to the removal of in-place asbestos. Do not sand, dry sweep, dry scrape, drill, saw, bead blast or pulverize any such existing product(s) unless you are certain they do not contain asbestos.

Preparation

Keep temperature of the room, subfloor, and tile at a minimum of 65 °F (18 °C) to a maximum of 85 °F (29 °C) for at least 48 hours prior to installation. If the tiles have been shipped in extreme weather conditions, under 40°F (4 °C) or over 95 °F the conditioning time should be a minimum of 72 hours.

- Remove all debris. Sweep and vacuum as necessary.
- Scrape off old adhesive. The surface does not have to be perfect but do remove large clumps of adhesive (> 1/16" high)
- Remove moldings or cove base. You will reinstall old moldings/cove base or new ones over the floor after completion.
- Repair any major surface imperfections (cracks over 3/8") sharp height transitions or voids in the subfloor.
- If necessary undercut door frames to allow tiles to fit underneath. (Instructions below)

Tile Orientation

The hidden interlock design of FreeStyle requires that the tiles must always be installed in the same rotational direction and with edges and corners in line with each other. Trying to install otherwise will damage the tiles

Interlocking Tiles

Prior to interlocking a tile, make sure it is properly aligned with the adjoining tile(s) and that the interlocks and the floor are free of debris. Align the corners and interlocks of each tile, placing a "Finished Edge" over the "Interlock Extension". Push down on the tile with the heel of your hand until you feel and see the tile has seated on the adjacent tile at the corner. Gradually work along the edge of the interlock, tapping firmly with the dead-blow hammer until edge is fully interlocked. If Tiles are not interlocking with relative ease recheck for proper rotation and alignment by removing the tile and starting the interlock engagement with the heel of your hand again before tapping joint together.

Continuing to hit improperly aligned tiles will damage the interlock

Planning Your Tile Layout

Like all tile products, layout planning begins by finding the center of the room or area to be covered and establishing lines to guide your layout. Unlike ceramic or vinyl tile products, FreeStyle installations should start in a corner of the room with the Finished Edges (See Figure 1) facing the walls. Use the steps outlined below to establish Control Lines and the Starting Point for your installation. Using these methods will provide an installation with balanced cut rows along each wall. Start the process along your longest straightest wall. Determine which corner will be your starting point. Do not start in a corner with a doorway.

Failure to carefully maintain a straight line on the first row of the installation will cause difficulty in the installation, particularly in large areas.

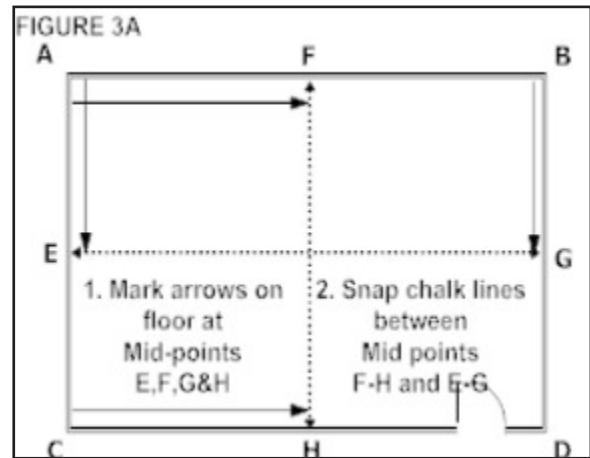

Figure 3A Establishing Midlines & Midpoints

Establish Midlines and Midpoint of Room

- Measure from point A to B. Record that measurement and divide it by 2
- Starting at Point A, measure to find the halfway point on wall AB. Mark that Midpoint with an arrow, as accurately as possible (See Point F)
- Repeat Steps 1 & 2 along wall CD.
- Snap a chalk line between these points, shown as line FH
- Repeat the process to find the midpoints on wall AC and wall BD.
- Snap a chalk line between these points, shown as line EG in Figure 2

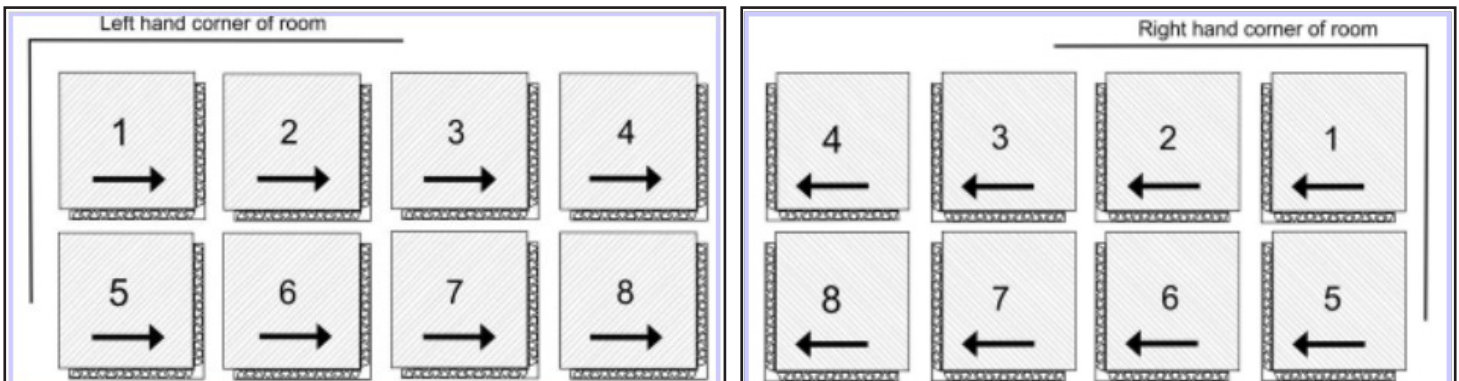

Figure 2 Tile Layout

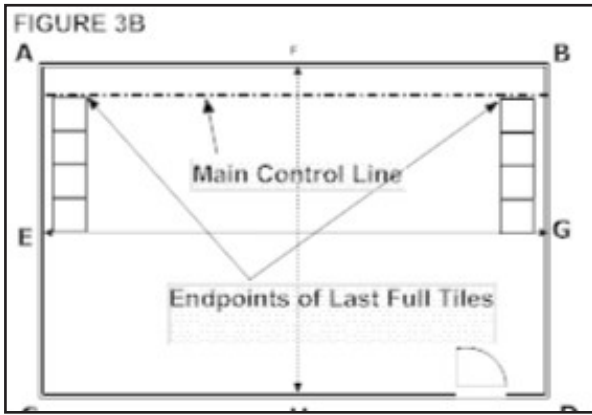

Figure 3B Establish Control Lines

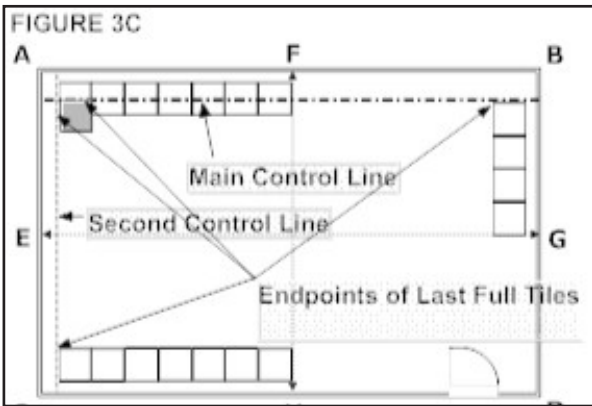

Figure 3C Establish Starting Point

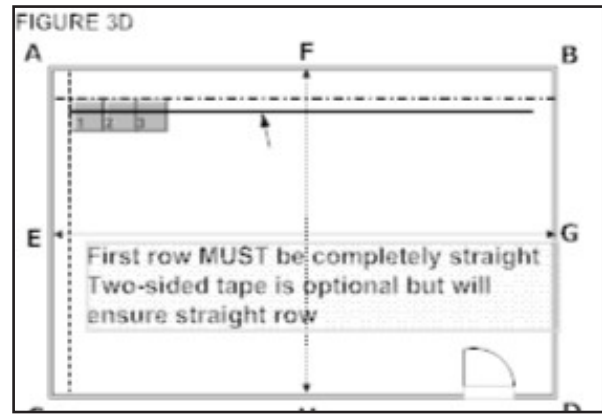

Figure 3D

Establish Control Lines and Starting Point

- Starting at Midline EG along Wall AC lay full tiles as shown to the point where a full tile will not fit.
- Carefully mark a point at the Finished Edge of the last tile. Note: You must mark that line at the Finished Edge of the tile, not at the edge of the Interlock Extensions (See FIGURE 1)
- You may either repeat the process, laying tiles along the opposite wall or multiply the number of full tiles by 18.5. Measure that length from the Midline to the wall and mark that point along the opposite wall.
- Snap a chalk line between these two points. This is the Main Control Line for your installation.
- Repeat the process along the other walls to determine the number of full tiles. That chalk line will be your Second Control Line
- The corner formed where the Main and Second Control Lines meet is the Start Point for your installation.

Install the Control Row

It is essential to keep the first row straight on the Control Line. This will keep the installation square and ensure easy installation. Failure to do so may cause gapped or excessively tight seams as you add rows. Two sided tape should be used under the third row of tiles to ensure that rows stays straight. Install a 2nd row. This is not necessary in smaller installations under 500 sq. ft. It should be used in any installation over 1000 sq. ft.

- If using tape, vacuum or sweep and damp mop the area of the floor under the area where the first row of tile will be installed to remove all dust. Allow to dry. This will ensure that the tape adheres to the floor.
- Install ROW 1 carefully along the control line. Install a 2nd row. Beginning at the point where the first tile will be placed on ROW 3 unroll the two-sided tape in a parallel line approximately 5" from the edge of ROW 2. Press tape firmly in place.
- Beginning at the Starting Point, remove approximately 6' of the protective paper from the top of the two-sided tape.
- Before starting ROW 3, CLOSELY check ROW 1 and adjust as needed to keep it on the control line. Put Tile 1 in ROW 3 lightly in place, carefully lining the Finished Edges up with the Main and Second Control Lines. DO NOT apply pressure yet so that adjustments can be made if necessary.
- Repeat with tiles 2 and 3, again carefully checking alignment with the Main Control line. Press interlocks to check alignment of tiles 2 and 3 but do NOT apply pressure over the area where the tape is on the floor so that final adjustments may be made if necessary.
- Once you are certain that the tiles and the interlocks are properly aligned, kneel on the first tile and press over the taped area to anchor the tile. Do the same with tiles 2 and 3, pressing them into place and then fully seating the interlocks with the deadblow hammer.
- Repeat this process, putting 3-4 tiles down at a time keeping a close eye on the Main Control Line until that row is complete.
- Once the taped line is in place, return to the starting point and install the next row of tiles and continue until all of the "field" tiles are installed.

Once you have established your Control Lines, if you find that the distance between either of the Control Lines to the wall is less than 6" you may want to begin with a full tile closest to the wall. In this case, or if you simply prefer the simpler installation with less cutting, follow all of the steps above. You will still establish two Control Lines but one or both of them may be close to the wall. In this case measure from each of the points marking the end of the last full tile to the wall. Snap a chalk line along the wall. This is your starting line.

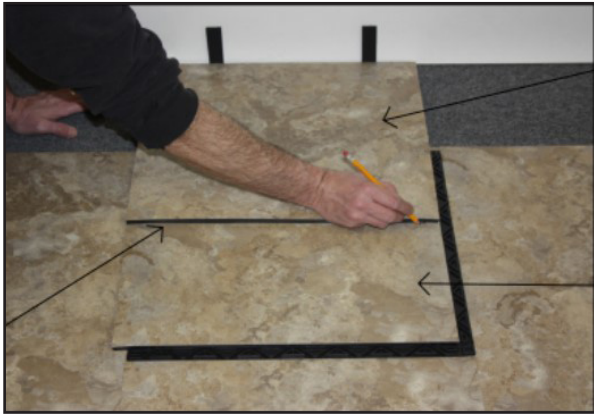

Figure 4 Measuring & Laying Cut Edge Tiles

Measuring and Laying Cut Edge Tiles

- Create an End Cut Template by cleanly removing the interlock extension from one tile.
- Beginning in a corner, place a loose tile over the installed corner tile. Line up the edges precisely. **BE SURE THE INTERLOCKS ARE ORIENTED THE SAME WAY AS THE INSTALLED TILE.**
- Lay the End Cut Template over the loose tile to be cut. Butt the template against the wall, placing 1/4" expansion spacers near the corners (you may use a "slice" of a tile to achieve a 5/16" space). Line up the other edges and mark a line where the template meets the loose tile.
- Remove the marked tile and cut along the drawn line.
- If required, gently lift the edge of the "field tile" and slide the cut tile Interlock Extension under the "field tile". Butt tiles together and align corners. Seat the tile corner with the heel of your hand. Use a dead blow hammer to finish seating the edges. Check to ensure minimum expansion space.
- Continue using this method around the perimeter of the room until all tiles are installed.
- For the best finish you will need to cut the door jamb moldings so the tiles fit freely under them. This is easily done with a "door jamb" or "undercut" saw available at most hardware stores. Cut the jamb using a tile to establish the proper cutting height.
Note: In some cases you will also have to cut the door bottom due to inadequate clearance. Your door should not rub anywhere on the tile when it is open and shut.

Settling Seams

Due to the tight seam design, tiles may initially pop up during installation. For best interlock joint seating, roll over all joints with a roller, applying pressure to the joints as you roll across them. You may repeat this process after the floor has had a chance to "settle in" for a few days. You may also go back over the floor, re-tapping any high points with the dead-blow hammer.

Transitions

To transition to the subfloor or to adjacent flooring install a transition piece. See FreeStyle Technical Bulletin 060114—FreeStyle Standard Reducers and Transitions for recommended options.

Rolling Loads

Heavy rolling loads can cause the tiles to compress and creep, and come unsnapped along traffic areas and particularly at turning or pivot points. To prevent this apply a releasable adhesive (Parabond M5080, or equal) in these areas only. Follow adhesive manufacturer's instructions for application.

Temperature Conditions

If you are installing the tiles in an area that is not maintained in the 62 °F to 75 °F degree temperature range the tiles will expand and/or contract more than in standard installations. Allow more expansion space for tiles installed in cool environments. Failure to do so may result in buckling. Allow for greater shrinkage for tiles installed in warm environments. Failure to do so may result in excessive gaps at walls or transitions. Where temperature swings in excess of 20 degrees may occur, expansion joints should be used.

Grounding FreeStyle 8400

It is recommended that a copper grounding wire be placed every 1,000 sq. ft. throughout the installation. Run the grounding wire from the tile surface to and electrical outlet or other building ground. Grounding Kits can be ordered from Statguard Flooring: [46270](#) - FreeStyle 8400™ Interlocking Floor System Grounding System.

Limited Warranty

Statguard Flooring expressly warrants that for a period of one (1) year from the date of purchase, Statguard Flooring products will be free of defects in material (parts) and workmanship (labor). Within the warranty period, a unit will be tested, repaired or replaced at Statguard Flooring's option, free of charge. Call our Customer Service Department at (781) 821-8370 (Canton, MA) for a Return Material Authorization (RMA) and proper shipping instructions and address. Please include a copy of your original packing slip, invoice, or other proof of date of purchase. Any unit under warranty should be shipped prepaid to the Statguard Flooring factory. Warranty replacements will take approximately two weeks.

For unusual conditions or extraordinary installations contact Statguard Flooring for guidance: (781) 821-8370.